

# Hybrid Stepping Motors

M174518K612

Issue 02

# Rotalink

Miniature Motors, Transmission and Control

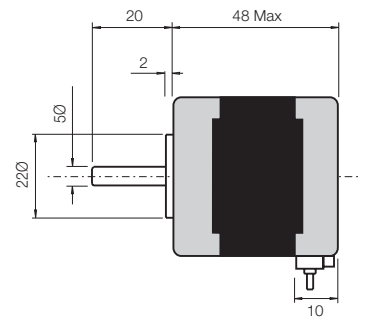
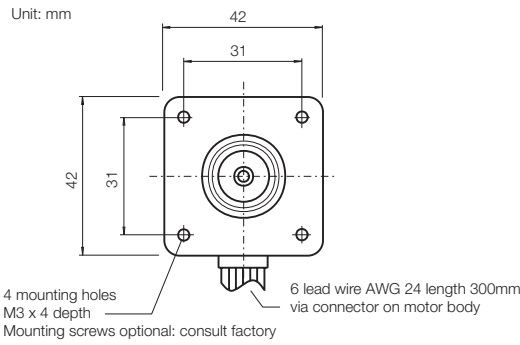

Model Number	Phase voltage (V)	Phase current (A)	Phase resistance ( $\Omega$ )	Phase inductance (mH)	Detent torque (mNm)	Winding
M174518K612	12.0	0.94	12.8	14.0	17.7	Uni-polar

## General Specification

Holding Torque	600mNm
Step angle	1.8°
Step accuracy	± 5%
Rotor Inertia	7.5 kgm <sup>2</sup> x10 <sup>-6</sup>
Temperature rise	80°C (max.)
Ambient temp. range	-20°C to +50°C
Insulation resistance	100M $\Omega$ (min) at 500V DC
Dielectric strength	500V AC 1min
Radial play	0.02mm (max.) with 450g load
Weight	350g

## Characteristics

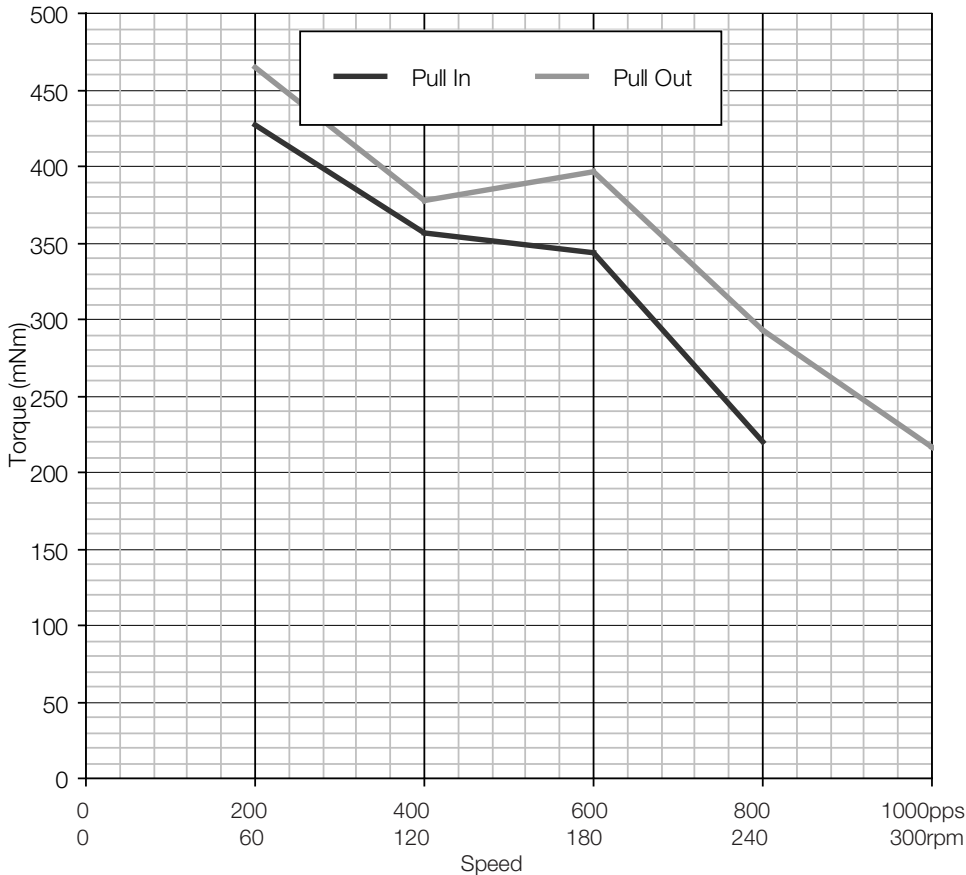

Drive: Full step Uni-polar chopper drive @ 24V & nominal phase current

## Full step uni-polar sequence

CW dir.	Step 1	Step 2	Step 3	Step 4
Blue	Off	Off	On	On
Orange	On	On	Off	Off
Red	Off	On	On	Off
Yellow	On	Off	Off	On

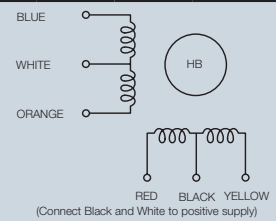

## Contact:

[www.rotalink.com](http://www.rotalink.com)  
[info@rotalink.com](mailto:info@rotalink.com)  
 T: +44 (0)1460 72000  
 F: +44 (0)1460 74278

Rotalink Limited  
 Cropmead, Crewkerne  
 Somerset TA18 7HQ, UK

[www.rotalink.com](http://www.rotalink.com)